

## Reduced Order Observer for the Longitudinal and Lateral Movements of an Aircraft

LUNGU ROMULUS  
Avionics Department  
University of Craiova, Faculty of Electrotechnics  
Blv. Decebal, No.107, Craiova, Dolj  
romulus\_lungu@yahoo.com  
ROMANIA

LUNGU MIHAI  
Avionics Department  
University of Craiova, Faculty of Electrotechnics  
Blv. Decebal, No.107, Craiova, Dolj  
lma1312@yahoo.com  
ROMANIA

STOENESCU ELEONOR  
Electric Department  
University of Craiova, Faculty of Electrotechnics  
Blv. Decebal, No.107, Craiova, Dolj  
estoenescu@elth.ucv.ro  
ROMANIA

CALBUREANU MADALINA  
Mechanics Department  
University of Craiova, Faculty of Mechanics  
Blv. Calea Bucuresti, no.107, Craiova, Dolj  
madalina.calbureanu@gmail.com  
ROMANIA

*Abstract:* - This paper presents an algorithm for identification of the longitudinal and lateral movements of an aircraft. For identification a reduced order observer has been projected. With the obtained reduced order observer a stabilization compensator has been made. To perform the identification, the authors use the Matlab program from Appendix and an algorithm for the feedback gain matrix obtaining (ALGLX algorithm). The obtained results show that the algorithm may be used with good results to any system's identification.

*Key-Words:* observer, reduced order, algorithm, stabilization, compensator.

### 1 Introduction

To use a control law one must know the state variables. From the practical point of view, because of high prices of the transducers and interfaces, the measurement of all state variables isn't advisable. The state observers are the solution to this problem; they estimate the process' states using only the input and the output vectors of the process [1], [2], [3].

The use of a state observer leads to important savings, especially in the case of a state vector with  $n$  components. Instead of  $n$  transducers and  $n$  measurement interfaces only one transducer and one interface will be used.

For estimate the states of an observer the system must be observable. That means that

the rank of the matrix  $Q$

$$Q^T = [C \ C \cdot A \ \dots \ C \cdot A^{n-1}] \quad (1)$$

must be equal with the lines' number of matrix  $A$  from the state general equations that describes a system

$$\begin{aligned} \dot{x} &= Ax + Bu, \\ y &= Cx + Du. \end{aligned} \quad (2)$$

For doing this in Matlab one uses the instruction **obsv** with the following syntax

$$Q = \text{obsv}(A, C); \ r = \text{rank}(Q);$$

The controllability and observability of a system are dual properties. That means that the pair  $(A, B)$  is controllable if pair  $(B^T, A^T)$  is observable. The pair  $(C, A)$  is observable if pair  $(A^T, C^T)$  is controllable.

In order to minimize the negative influence of the sensors' errors it's advisable to project a reduced order observer. These observers (minimal observers) may be used with very good results in the case of systems with only one output when this output is one of the state variables. In this case one needn't to measure all the states, one of them being already available; a reduced form of prediction observer may be used (it gives only  $n - 1$  state variables).

## 2 The project of a reduced order state observer

Let's consider  $x$  to be the state vector,  $x_2$  – the measured (known) output variable and  $x_1$  – the vector containing unknown state variables. From the first state equation (2) it results [4]

$$\begin{bmatrix} \dot{x}_1 \\ \dot{x}_2 \end{bmatrix} = \begin{bmatrix} A_{11} & A_{12} \\ A_{21} & A_{22} \end{bmatrix} \cdot \begin{bmatrix} x_1 \\ x_2 \end{bmatrix} + \begin{bmatrix} B_1 \\ B_2 \end{bmatrix} \cdot u \quad (3)$$

or

$$\begin{aligned} \dot{x}_1 &= A_{11}x_1 + A_{12}x_2 + B_1u, \\ \dot{x}_2 &= A_{21}x_1 + A_{22}x_2 + B_2u. \end{aligned} \quad (4)$$

From the second equation (4) it results

$$\dot{x}_2 - A_{21}x_1 - A_{22}x_2 - B_2u = 0. \quad (5)$$

One obtains

$$\dot{x}_1 = A_{11}x_1 + A_{12}x_2 + B_1u - L_{or}(\dot{x}_2 - A_{21}x_1 - A_{22}x_2 - B_2u), \quad (6)$$

$$\dot{\hat{x}}_1 = A_{11}\hat{x}_1 + A_{12}x_2 + B_1u - L_{or}(\dot{x}_2 - A_{21}\hat{x}_1 - A_{22}x_2 - B_2u)$$

or

$$\dot{\hat{x}}_1 = (A_{11} + L_{or})\hat{x}_1 + (A_{12} + L_{or}A_{22})x_2 + (B_1 + L_{or}B_2)u - L_{or}\dot{x}_2. \quad (7)$$

where  $\hat{x}_1$  is the estimate of vector  $x_1$ ,  $x_2 = \hat{x}_2$  and  $L_{or}$  is the gain matrix of the reduced order observer.

This matrix will be determined.

Considering the dimensions for the matrices

$$A(n \times n), B(n \times q), u(q \times 1), x_2(p \times 1), x_1((n - p) \times 1), \quad (8)$$

the above matrices have the following dimensions

$$A_{11}((n - p) \times (n - p)), A_{12}((n - p) \times p), A_{21}(p \times (n - p)), \quad (9)$$

$$A_{22}(p \times p), B_1((n - p) \times q), B_2(p \times q).$$

One makes notation

$$e = \hat{x}_1 - x_1 \quad (10)$$

and taking into account equations (6) and (7) it results the equation of the reduced order observer [4]

$$\dot{e} = (A_{11} - L_{or}A_{21}) \cdot e; \quad (11)$$

The gain matrix of the observer  $L_{or}$  is obtained using instructions **acker** or **place** and assessing the eigenvalues of matrix  $A_{11} - L_{or}A_{21}$  (vector P) [4]

$$L_{or} = \mathbf{acker}(A_{11}^T, A_{21}^T, \mathbf{P}); L_{or} = L_{or}^T;$$

$$L_{or} = \mathbf{place}(A_{11}^T, A_{21}^T, \mathbf{P}); L_{or} = L_{or}^T;$$

With this observer one may obtain a stabilization compensator (fig.1) whose output is the

desired control law

$$u = -K\hat{x} = -[K_1 \quad K_2] \cdot \begin{bmatrix} \hat{x}_1 \\ \hat{x}_2 \end{bmatrix} = -K_1\hat{x}_1 - K_2\hat{x}_2, \quad (12)$$

where the partitioning of the matrix  $K$  is made as follows

$$K_1(q \times (n - p)), K_2(q \times p). \quad (13)$$

The calculus of matrix  $K$  is made using instructions **acker** and **place**; instead of matrix  $A_{11}^T$  matrix  $A^T$  is now used and instead of matrix  $A_{21}^T$  matrix  $B^T$  is used. This is another case when some eigenvalues must be asset for the matrix  $A - BK$ .

The obtaining of matrix  $K$  is made, both for longitudinal and lateral movements of the aircraft, using the authors' algorithm (ALGLX algorithm) [5]. Between the eigenvalues of the observer and the eigenvalues of matrix  $A - BK$  there is the following relationship

$$|\operatorname{Re}\{\lambda_{\min}\}_{observer}| > 5 \div 10 |\operatorname{Re}\{\lambda_{\max}\}_{system}|. \quad (14)$$

That means that the eigenvalues of the observer are chosen such that their minimum real part is 5 ÷ 10 times bigger than maximum real part of the system's eigenvalues.

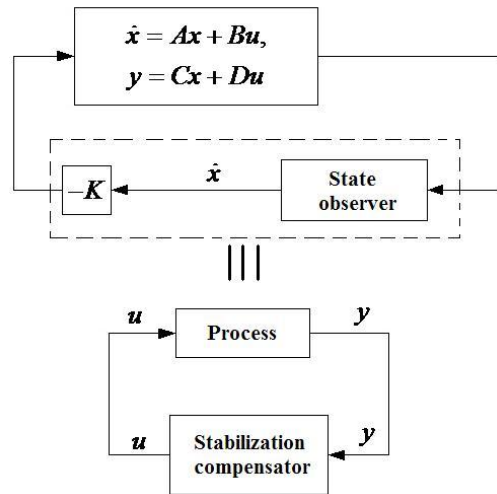

Fig.1. Block diagram of the stabilization compensator with reduced order observer

Considering [4]

$$\dot{\hat{x}}_1 = w + L_{or}x_2, \quad (15)$$

The compensator's equations become

$$\dot{w} = A_c w + B_c x_2, \quad (16)$$

$$u = C_c w + D_c x_2,$$

where

$$\begin{aligned} A_c &= A_{11} - B_1K_1 - L_{or}A_{21} + L_{or}B_2K_1, \\ B_c &= A_{11}L_{or} - L_{or}A_{21}L_{or} + A_{12} - L_{or}A_{22} - \\ &\quad - (B_1 - L_{or}B_2) \cdot (K_1L_{or} + K_2), \end{aligned} \quad (17)$$

$$C_c = -K_1,$$

$$D_c = -K_1L_{or} - K_2.$$

Taking into account that the  $n-p$  estimated states are given by (15), if the initial state of the observer isn't zero, then the observer has the initial state

$$w_0 = \hat{x}_{i_0} - L_{or}x_{2_0}. \quad (18)$$

If  $\hat{x}_{i_0} = 0$ , the initial value of  $x_2(x_{2_0})$  represents the output  $y$  in the first moment ( $y_0$ ). This means that the minimal state observer will "start" from initial state  $-L_{or}x_{2_0}$ ; while the initial value of the last state isn't zero this state differs from zero.

The transfer function of the reduced order observer is

$$H_{or}(s) = C_c(sI - A_c)^{-1}B_c + D_c. \quad (19)$$

### 3 Stabilization compensator with reduced order observer for the longitudinal movement of an aircraft

Lets' consider the case of the non-dimensional longitudinal movement of an aircraft [5]

$$\begin{bmatrix} \dot{\hat{V}} \\ \dot{\hat{\alpha}} \\ \dot{\hat{\theta}} \\ \dot{\hat{\omega}}_y \end{bmatrix} = \begin{bmatrix} -0.026 & 0.025 & -0.1 & 0 \\ -0.36 & -3 & 0 & 1 \\ 0 & 0 & 0 & 1 \\ 0.4212 & -38.49 & 0 & -3.67 \end{bmatrix} \begin{bmatrix} \hat{V} \\ \hat{\alpha} \\ \hat{\theta} \\ \hat{\omega}_y \end{bmatrix} + \begin{bmatrix} 0 \\ 0 \\ 0 \\ 1 \end{bmatrix} \delta_p, \quad (20)$$

where

$$\hat{V} = \frac{\Delta V}{V^*}, \hat{t} = \frac{t}{\tau_a}, \hat{\omega}_y = \frac{\bar{b}}{V^*} \omega_y, \hat{\theta} = \Delta\theta, \hat{\alpha} = \Delta\alpha; \quad (21)$$

$\tau_a = 2,1s$  – the aerodynamic time constant,  $\Delta V$  – the variation of the flight velocity,  $\theta$  – the pitch angle,  $\alpha$  – the attack angle,  $V^*$  – rectilinear uniform flight's velocity,  $\delta_p$  – the rudder deflection.

The system is considered to be a system with one input ( $\delta_p$ ) and one output ( $\hat{\omega}_y$ ).

$$C = [0 \ 0 \ 0 \ 1]; D = [0]. \quad (22)$$

For the reduced order observer's project, matrices  $A, B, K$  must be partitioned. One considers that only the fourth state variable is measured. That means  $p = 1$  and the number of variables that must be estimated is  $n - p = 4 - 1 = 3$ .

Because the eigenvalues of the matrix  $A - BK$  aren't known, the authors use the ALGLX algorithm [5] in order to obtain the gain matrix  $K$ . After this purpose is achieved, using the eigenvalues of matrix  $A - BK$  and equation (14), the eigenvalues of matrix  $A_{11} - L_{or}A_{21}$  are obtained (the eigenvalues of the observer).

With the program from Appendix one obtains matrix  $K$

$$K = [0.547 \ -5.020 \ 6.897 \ 0.539]. \quad (23)$$

Using the Matlab program it results

$$A_{11} = \begin{bmatrix} -0.026 & 0.025 & -0.1 \\ -0.36 & -3 & 0 \\ 0 & 0 & 0 \end{bmatrix}; A_{12} = \begin{bmatrix} 0 \\ 1 \\ 1 \end{bmatrix}; A_{21}^T = \begin{bmatrix} 0.4212 \\ -38.49 \\ 0 \end{bmatrix};$$

$$A_{22} = -3.67; B_1 = \begin{bmatrix} 0 \\ 0 \\ 0 \end{bmatrix}; B_2 = 1;$$

$$K_1 = [0.5486 \ -5.0231 \ 6.8973]; K_2 = 0.5392.$$

For the stabilization compensator one obtains

$$A_c = 10^3 \cdot \begin{bmatrix} 0.0028 & 0.7532 & 0.1551 \\ -0.0004 & -0.0222 & -0.0039 \\ -0.0148 & -3.8873 & -0.8012 \end{bmatrix}; B_c = 10^4 \cdot \begin{bmatrix} -1.8291 \\ 0.046 \\ 9.4462 \end{bmatrix};$$

$$C_c = [-0.5486 \ 5.0231 \ -6.8973]; D_c = 785.3947.$$

The program from Appendix calculates the gain matrix of the reduced order observer -  $L_{or}$ , the transfer function of the stabilization compensator with reduced order observer -  $H_{cor}(s)$ , closed loop transfer function for the system with compensator and positive reaction -  $H_{or}(s)$  and the poles and zeros of this function  $pol_{or}, zero_{or}$

$$L_{or}^T = [22.5057 \ -0.5723 \ -116.1543],$$

$$H_{cor}(s) = \frac{785.4s^3 + 5204s^2 + 3.86 \cdot 10^4 s - 1764}{s^3 + 820.5s^2 + 2686s + 205.2},$$

$$H_{or}(s) = \frac{s^6 + 823.5s^5 + 5169s^4 + 8404s^3 + 854.6s^2 + 17.85s + 2.73 \cdot 10^{-13}}{s^7 + 41.77s^6 + 648.9s^5 + 4537s^4 + 2.043 \cdot 10^3 s^3 + 1.704 \cdot 10^4 s^2 + 4492s + 310.3}$$

$$pol_{or} = -16.9992 + 6.2155i; -16.9992 - 6.2155i; -3.3998 + 6.2155i;$$

$$-3.3998 - 6.2155i; -0.5361; -0.3283; -0.1072,$$

$$zero_{or} = -817.1819; -3.2083; -2.9970; -0.0783; -0.0290; 0.0.$$

The block diagram of the stabilization compensator with reduced order observer is the one from fig.2 (the subsystems are in fig.3).

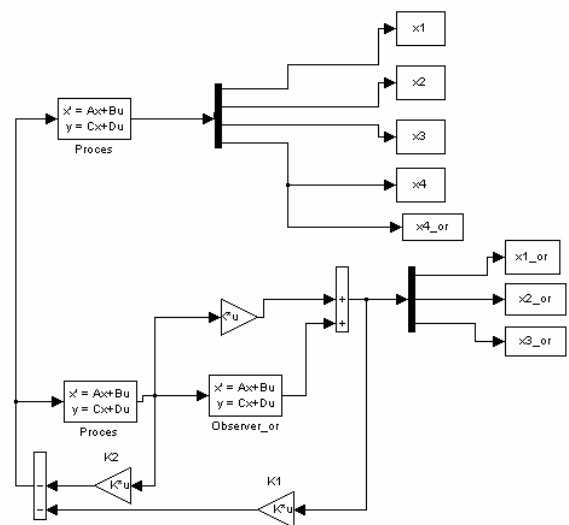

Fig.2. Block diagram of the stabilization compensator with reduced order observer

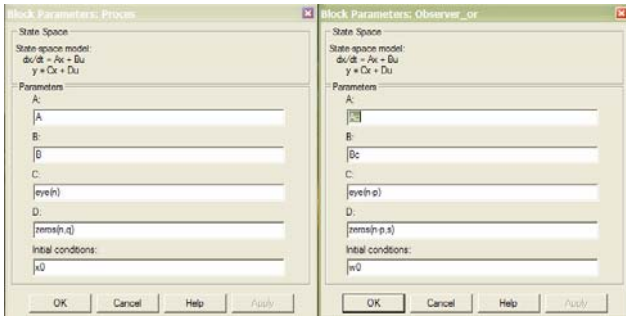

Fig.3. The subsystems of system from fig.2

Using the Matlab program from Appendix and the model Matlab/Simulink from fig.2 one obtains the indicial response of the closed loop system (fig.4) and time variations of the components of the state vectors  $x$  and  $\hat{x}$  ( $x$  with blue color and  $\hat{x}$  with red color).

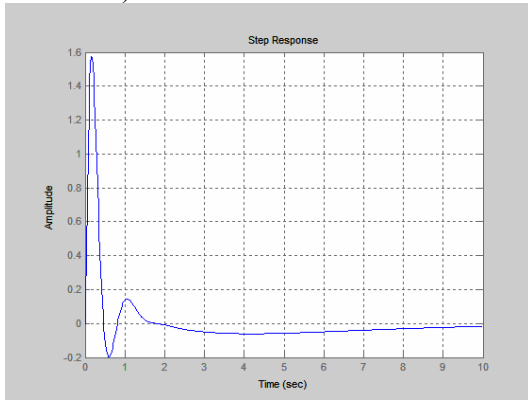

Fig.4. The indicial response of the closed loop system (longitudinal movement)

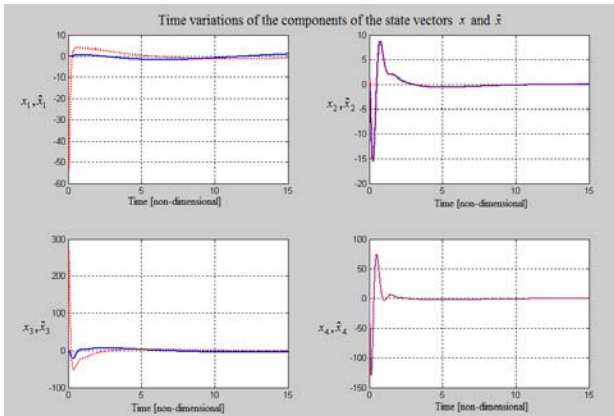

Fig.5. Time variations of the components of the state vectors  $x$  and  $\hat{x}$  (longitudinal movement)

#### 4 Stabilization compensator with reduced order observer for the lateral movement of an aircraft

Let's consider now the case of the lateral movement of a fight aircraft which flies with  $M=1.5$ , at  $H=10000$  ft, with values from [6]; the state vector and the input vector are

$$x^T = [\Delta\beta \quad \Delta\omega_x \quad \Delta\omega_z \quad \Delta\varphi], u^T = [\delta_f \quad \delta_d]; \quad (24)$$

$\beta$  is the sideslip angle,  $\omega_x$  – the roll angular velocity,  $\omega_z$  – the yaw angular velocity,  $\varphi$ – the roll angle,  $\delta_f$  – the flaps deflection,  $\delta_d$  – the direction deflection. The matrices from state equations (2) are

$$A = \begin{bmatrix} -0.493 & 0.015 & -1 & 0.02 \\ -61.176 & -7.835 & 4.991 & 0 \\ 31.804 & -0.235 & -0.994 & 0 \\ 0 & 1 & -0.015 & 0 \end{bmatrix}, B = \begin{bmatrix} -0.002 & 0.002 \\ 8.246 & 1.849 \\ 0.249 & -0.436 \\ 0 & 0 \end{bmatrix}, \quad (25)$$

$$C = [0 \ 0 \ 0 \ 1], D = [0 \ 0].$$

This time the system is a system with two inputs (the deflection of the flaps and the deflection of the direction) and one output ( $\Delta\varphi$ ). As a consequence will be obtained two transfer functions (the first associated to the input  $\delta_f$  and output  $\Delta\varphi$  and the second associated to the input  $\delta_d$  and the output).

The methodology is the same with the one presented above for the longitudinal movement of the aircraft. With the ALGLX algorithm one obtains the gain matrix  $K$

$$K = \begin{bmatrix} 8.209 & 0.967 & 0.658 & 4.223 \\ -7.844 & -0.183 & -7.952 & -2.619 \end{bmatrix}.$$

For the reduced order observer's project matrices  $A, B, K$  must be partitioned

$$A_{11} = \begin{bmatrix} -0.493 & 0.015 & -1 \\ -61.176 & -7.835 & 4.991 \\ 31.804 & -0.235 & -0.994 \end{bmatrix}; A_{12} = \begin{bmatrix} 0.02 \\ 0 \\ 0 \end{bmatrix};$$

$$A_{21} = [0 \ 1 \ -0.015]; A_{22} = 0;$$

$$B_1 = \begin{bmatrix} -0.002 & 0.002 \\ 8.246 & 1.849 \\ 0.249 & -0.436 \end{bmatrix}; B_2 = [0 \ 0];$$

$$K_1 = \begin{bmatrix} 8.209 & 0.967 & 0.658 \\ -7.844 & -0.183 & -7.952 \end{bmatrix}; K_2 = \begin{bmatrix} 4.223 \\ -2.619 \end{bmatrix}.$$

For the stabilization compensator's project one obtains

$$A_c = \begin{bmatrix} -0.4609 & 13.903 & -1.1911 \\ -114.363 & -98.746 & 15.515 \\ 26.339 & -172.913 & -2.04 \end{bmatrix}; B_c = 10^4 \cdot \begin{bmatrix} 0.0959 \\ -0.3991 \\ -1.5119 \end{bmatrix};$$

$$C_c = \begin{bmatrix} 8.20 & -0.96 & -0.65 \\ 7.84 & 0.18 & 7.95 \end{bmatrix}; D_c = 10^3 \cdot \begin{bmatrix} -0.08 \\ 1.27 \end{bmatrix}.$$

The Matlab program calculates the gain matrix of the reduced order observer ( $L_{or}$ ) the poles of the two closed loop transfer functions ( $pol_{or1}$ ,  $pol_{or2}$ ) and of the two closed loop transfer functions ( $H_{pred1}(s) = \Delta\varphi(s)/\delta_f(s)$ ,  $H_{pred2}(s) = \Delta\varphi(s)/\delta_d(s)$ ).

$$L_{or}^T = [-13.885 \ 83.273 \ 172.357]$$

$$pol_{or1} = -45.7588 + 47.6937i; -45.7588 - 47.6937i; -13.1415; -0.7699 + 5.8102i; -0.7699 - 5.8102i; -2.1851 + 0.9935i; -2.1851 - 0.9935i;$$

$$pol_{or2} = -74.7516; -23.6888; -3.4965 + 11.1953i; -3.4965 - 11.1953i; -2.3773 + 4.6511i; -2.3773 - 4.6511i; -0.3813.$$

$$H_{ori}(s) = \frac{-8.88 \cdot 10^{-15}s^6 + 8.24s^5 + 848.1s^4 + 3.91 \cdot 10^4s^3 + 7.01 \cdot 10^5s^2 + 1.63 \cdot 10^6s + 7.2 \cdot 10^6}{s^7 + 110.6s^6 + 6237s^5 + 9.54 \cdot 10^4s^4 + 6.71 \cdot 10^5s^3 + 3.59 \cdot 10^6s^2 + 1.023 \cdot 10^7s + 1.136 \cdot 10^7}$$

$$H_{or2}(s) = \frac{1.85s^5 + 188.4s^4 + 8530s^3 + 5.29 \cdot 10^4s^2 + 1.59 \cdot 10^5s + 8.21 \cdot 10^5}{s^7 + 110.6s^6 + 3167s^5 + 4.23 \cdot 10^4s^4 + 4.53 \cdot 10^5s^3 + 2.03 \cdot 10^6s^2 + 7.35 \cdot 10^6s + 2.534 \cdot 10^6}$$

To obtain indicial responses (fig.6 and fig.7), time variations of the components of the state vectors  $x$  and  $\hat{x}$  ( $x$  with blue color and  $\hat{x}$  with red color) (fig.8) and time variations of the four components of error vector  $e = x - \hat{x}$  (fig.9) the diagram block from fig.2 is used.

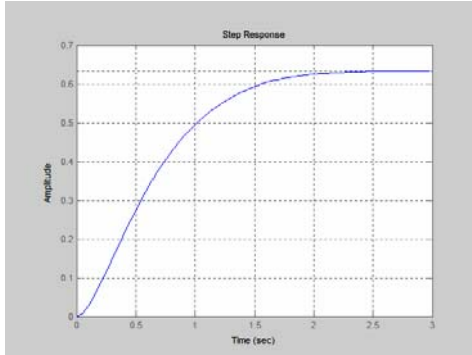

Fig.6. Indicial response of the system (input 1) for the lateral movement

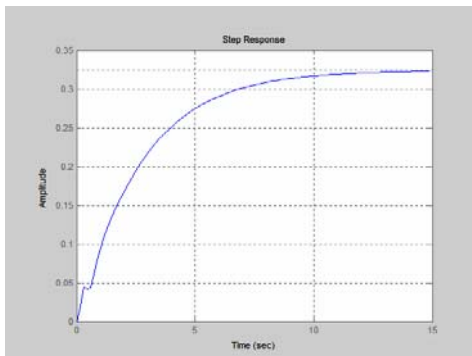

Fig.7. Indicial response of the system (input 2) for the lateral movement

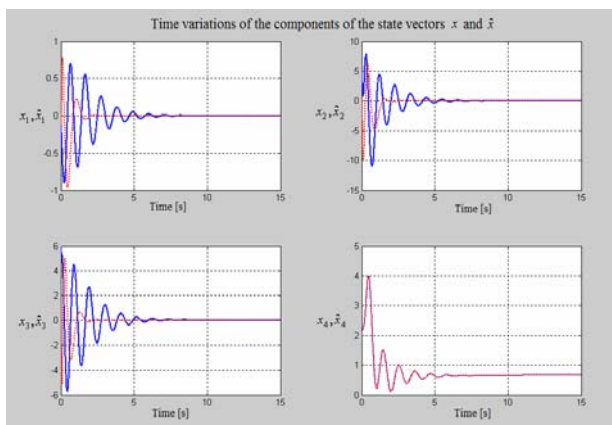

Fig.8. Time variations of the components of the state vectors  $x$  and  $\hat{x}$  (lateral movement)

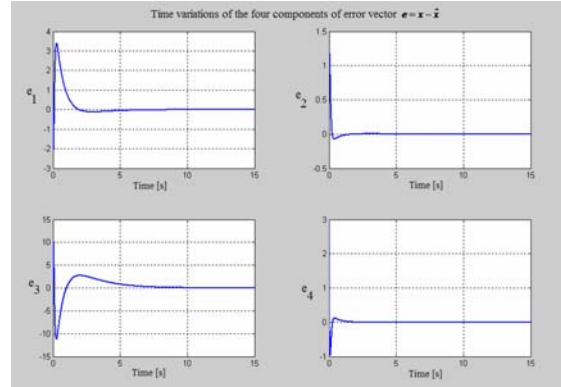

Fig.9. Time variations of the four components of error vector  $e = x - \hat{x}$  (lateral movement)

## 5 Appendix

close all; clear all;

A=[-0.026 0.025 -0.1 0;-0.36 -3 0 1;0 0 0 1;  
0.4212 -38.49 0 -3.67]; B=[0;0;0;1];

Q=[10 0 0 0;0 10 0 0;0 0 100 0;0 0 0 1];R=[2];

[K,P,E] = LQR(A,B,Q,R);I2=[1 0;0 1];

N3=randn(4,3); T(:,1)=B(:,1);

for i=1:4

for j=1:3

T(i,j+1)=N3(i,j);

end

end

Ab=(inv(T))\*A\*T; Bb=(inv(T))\*B;

Kb=place(Ab,Bb,E);e=eig(Ab-Bb\*Kb);

k1=Kb(1);k21=Kb(2);k22=Kb(3);k23=Kb(4);

r1=1;Rb=[r1];R=Rb; Pb=r1\*[k1 k21 k22 k23;k21 1  
0 0; k22 0 1 0; k23 0 0 1];

ee=eig(Rb);

Qb=-(Pb\*Ab+(transpose(Ab))\*Pb-Pb\*Bb\*Kb);

PPP=transpose(inv(T))\*Pb\*inv(T);

KKK=inv(R)\*transpose(B)\*PPP;

EEE=eig(A-B\*KKK);m=rank(T);

while real(EEE(1))>0 | real(EEE(2))>0 |

real(EEE(3))>0 | real(EEE(4))>0 | m<4

N3=randn(4,3);T(:,1)=B(:,1);

for i=1:4

for j=1:3

T(i,j+1)=N3(i,j);

end

end

Ab=(inv(T))\*A\*T;Bb=(inv(T))\*B;

Kb=place(Ab,Bb,E);e=eig(Ab-Bb\*Kb);

k1=Kb(1);k21=Kb(2);k22=Kb(3);k23=Kb(4);

r1=5;Rb=[r1];R=Rb; Pb=r1\*[k1 k21 k22 k23;k21 1  
0 0; k22 0 1 0; k23 0 0 1];

ee=eig(Rb);

Qb=-(Pb\*Ab+(transpose(Ab))\*Pb-Pb\*Bb\*Kb);

PPP=transpose(inv(T))\*Pb\*inv(T);

KKK=inv(R)\*transpose(B)\*PPP;

```

EEE=eig(A-B*KKK);m=rank(T);
end
Q=transpose(inv(T))*Qb*inv(T);R=Rb;
[KK,PP,EE] = LQR(A,B,Q,R); K=KK;
% Longitudinal movement n=4
clear Ab; clear Bb; clear i;
% System's matrices
n=size(A,1);q=size(B,2);
C=[0 0 0 1];s=size(C,1); D=zeros(s,q);
x0=[0;1;2;3]; % Initial system's state
% Process transfer function
[num_d,den_d]=ss2tf(A,B,C,D);
% Eigenvalues of matrix(A-B*K)
pp=eig(A-B*K);
% Eigenvalues of the prediction observer
for j=1:length(pp)
R(j)=real(pp(j)); I(j)=imag(pp(j));
RR=R*5; II=I;
ee(j)=RR(j)+II(j)*i; qq=ee';
end
OB=obsv(A,C);CO=ctrb(A,B);
r1=rank(OB);r2=rank(CO);
% Number of outputs measured by sensors
p=1;
% Partitioning of the matrices
A11=A(1:(n-p),1:(n-p));
A12=A(1:(n-p),(n-p+1):n);
A21=A((n-p+1):n,1:(n-p));
A22=A((n-p+1):n,(n-p+1):n);
B1=B(1:(n-p),1:q);B2=B((n-p+1):n,1:q);
K1=K(1:q,1:(n-p));K2=K(1:q,(n-p+1):n);
qq_or=qq(1:(n-p));
% Matrix L_or determination
L_or=place(A11',A21',qq_or); L_or=L_or';
% State equations of the stabilization compensator
Ac=A11-B1*K1-L_or'*A21+L_or'*B2*K1;
Bc=A11*L_or-L_or'*A21*L_or+A12-L_or'*A22-
(B1-L_or'*B2)*(K1*L_or+K2);
Cc=-K1; Dc=-K1*L_or-K2;
% Initial state of the observer
w0=x0_obs(1:(n-p))-L_or'*x0((n-p+1):n,:);
% Transfer function of the compensator
[num_cor,den_cor]=ss2tf(Ac,Bc,Cc,Dc);
% Closed loop transfer function
[num_or,den_or]=feedback(num_d,den_d,num_cor,
den_cor,+1);
pol_or=roots(den_or); zero_or=roots(num_or);
sys_d=tf(num_d,den_d);
sys_cor=tf(num_cor,den_cor);
sys_or=tf(num_or,den_or);
% State variables time variations
sim('Comp_obs_or_long');
e1=x1-x1_or;e2=x2-x2_or;
e3=x3-x3_or;e4=x4-x4_or;
t=linspace(0,15,length(x1));
    
```

```

step(sys_or);grid;h=figure;
subplot(221);plot(t,x1,t,x1_pred,'r');
grid;xlabel('Time [adim]');
subplot(222);plot(t,x2,t,x2_pred,'r');
grid;xlabel('Time [adim]');
subplot(223);plot(t,x3,t,x3_pred,'r');
grid;xlabel('Time [adim]');
subplot(224);plot(t,x4,t,x4_pred,'r');
grid;xlabel('Time [adim]'); h=figure;
subplot(221);plot(t,e1);grid;xlabel('Time [adim]');
subplot(222);plot(t,e2);grid;xlabel('Time [adim]');
subplot(223);plot(t,e3);grid;xlabel('Time [adim]');
subplot(224);plot(t,e4);grid;xlabel('Time [adim]');
    
```

## 6 Conclusion

For identification of the longitudinal and lateral movement of an aircraft, a reduced order observer has been projected. In Appendix is presented a Matlab program for the longitudinal movement of the aircraft. The obtained results show that the algorithm may be used with good results to any system's identification. All the variables tend to zero; this is very good because these variables are preceded by the symbol  $\Delta$  (the variables are, in fact, variations of some angles, angular velocities and so on). To perform the identification, the authors has used the algorithm for the feedback gain matrix obtaining (ALGLX) [5].

### References:

- [1] Donald, Mc.L. *Automatic Flight Control Systems*. New York, London, Toronto, Sydney, Tokyo, Singapore.
- [2] Sîngeorzan, D. *Regulatoare adaptive*. Editura Militară, București, 1992.
- [3] Yuan, Y., Yu, P., Librescu, L., Marzocca, P. *Aeroelasticity of Time – Delayed Feedback Control of Two – Dimensional Supersonic Lifting Surfaces*. Journal of Guidance, Control and Dynamics. Vol. 27, nr. 5, 2004, pag. 795 – 804.
- [4] Ilaș, M., Priboianu, M. *Teoria sistemelor de reglare automata. Indrumar de laborator*. Ed. Matrix Romanai, Bucuresti, 2004.
- [5] Lungu, M. *Sisteme de conducere a zborului*. Editura Sitech, Craiova, 2008, 329 pag. ISBN 978-973-746-975-5.
- [6] Choi, J.W. *LQR Design with Eigenstructure Assignment Capability*. IEEE Transactions on Aerospace and Electronic Systems, vol. 35, Nr.2, April, 1999, pag. 700 – 707.